

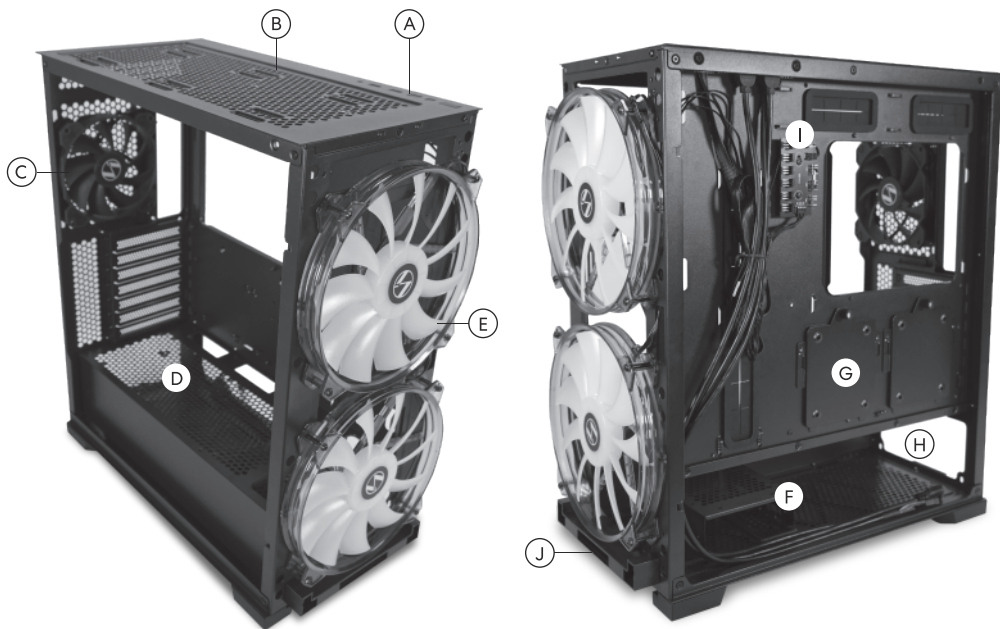

# LANCOOL 215



Installation Guide / Guide d'installation  
Montageanleitung / Guía de instalación  
安裝說明書 / インストールガイド



(A) IO ports : Audio x1 / Microphone Combo Jack , USB 3.0 x2 , Power Button , Reset Button

---

(B) Fan Supporting : 120mm x2 or 140mm x2 / Radiator : 240mm x1 or 280mm x1

---

(C) Rear Fan : 120mm x1

---

(D) Fan Supporting : 120mm x 2

---

(E) 200mm fan x2 in front panel

---

(F) Hard Drive Cage : HDD x2 / HDD x1 + SSD x1

---

(G) Behind MB Tray : SSD x2

---

(H) PSU : 210mm

---

(I) ARGB fan control board

---

(J) LOGO ARGB LEDs

---



Hardware list / Liste du matériel / Hardwareliste  
Lista de hardware / 付属品一覧 / 零件盒部品一覧表

a



x17 pcs

Screws for motherboard  
and 2.5" SSD mount

b



x8 pcs

Screws  
for 3.5" HDD mount

c



x6 pcs

Screws  
for PSU mounting

d



x3 pcs

Spare motherboard  
stand off

e



x1 pcs

Tool for stand of bolt

f



x8 pcs

Cable ties  
for cable management

g



x8 pcs

Fan long screws  
for inside 120mm fan.

h



x12 pcs

Fan screws  
for top panel fan.

Exceeded quantity are spare parts.

Les quantités dépassées sont des pièces de rechange.

Überschüssige Menge sind Ersatzteile.

La cantidad excedida son repuestos.

数量超過はスペアパーツです。

多餘的零件數量為備品



① Handle, Pull to release



② Pull forward

Remove the screws and open the side panel.

Left side panel

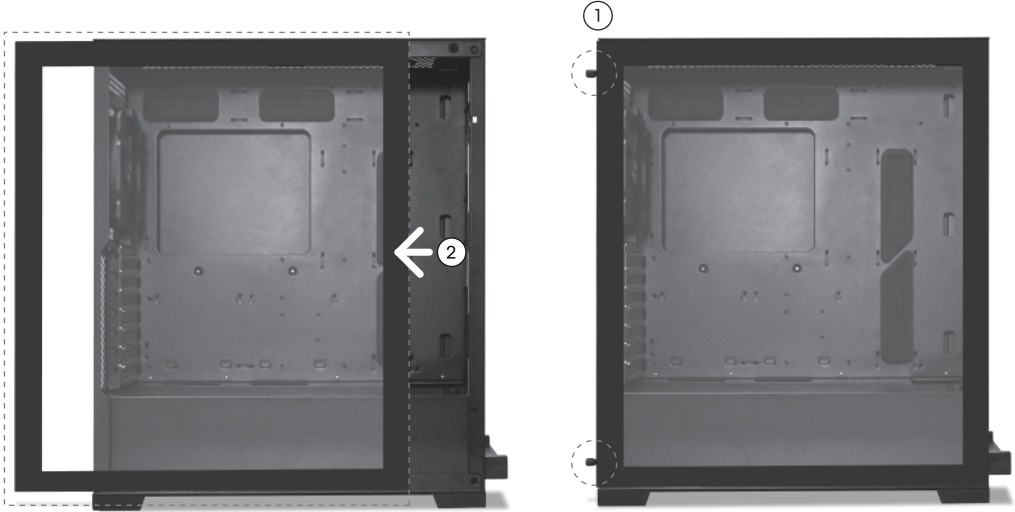

Right side panel

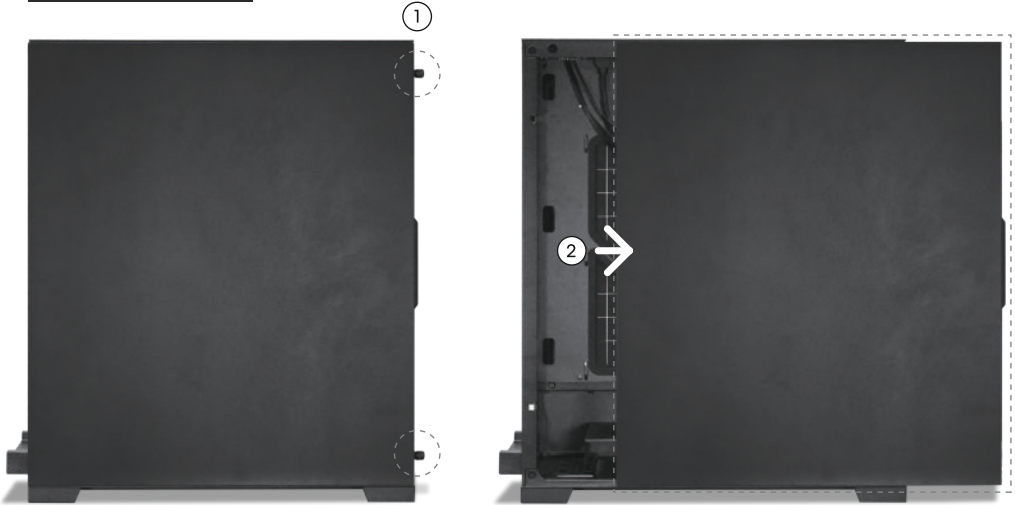



Motherboard installation / Installation de la carte mère / Motherboard-  
Installation / Instalación de la placa base / マザーボードの取り付け / 主機板安裝

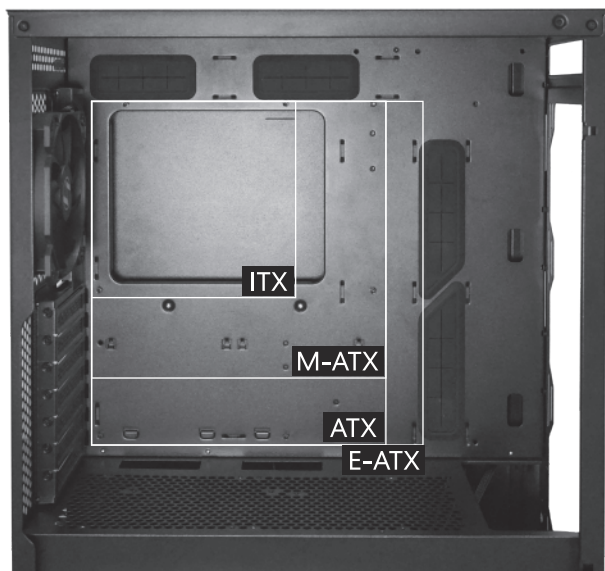

Tool for remove stand off bolt



PSU installation / Installation du bloc d'alimentation / Installation des Netzteils  
Instalación de la fuente de alimentación / 電源の取り付け / 電源供應器安裝

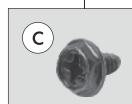
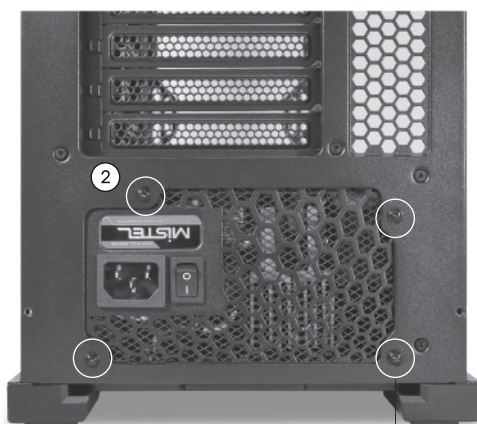



Hard disk installation / Installation du disque dur / Festplatteninstallation  
Instalación del disco duro / ハードディスクの取り付け / 硬碟安裝

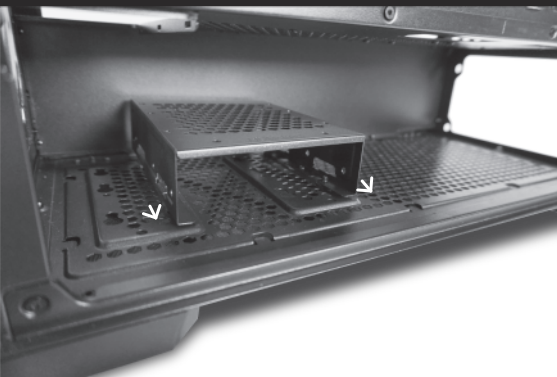

① Push forward and remove upward



⚠ When installing the front panel radiator, the hard disk cannot be installed in this hole.

②



Push in the hard drive cage, align the holes and lock the screws to fix.

Hard Drive Cage : HDD x2

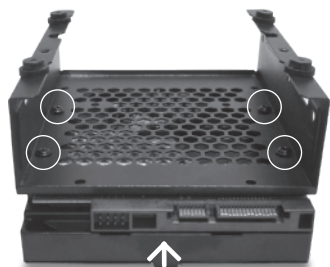

Or HDD x1 + SSD x1

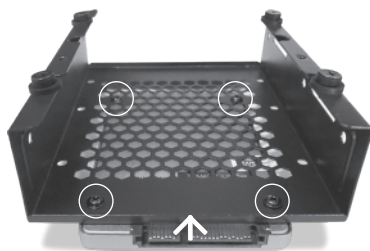



Behind MB Tray : SSD x2

Remove the screw  
and push up the tray.



Insert the SSD hard drive  
and tighten the screws.

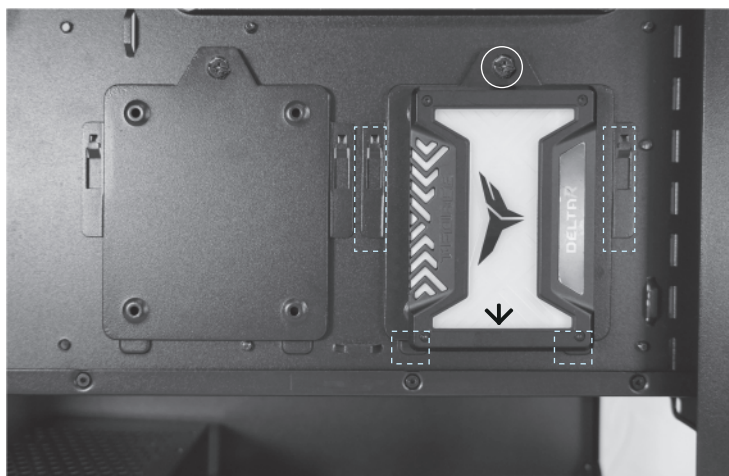

Clamp the position  
and lock the screw.



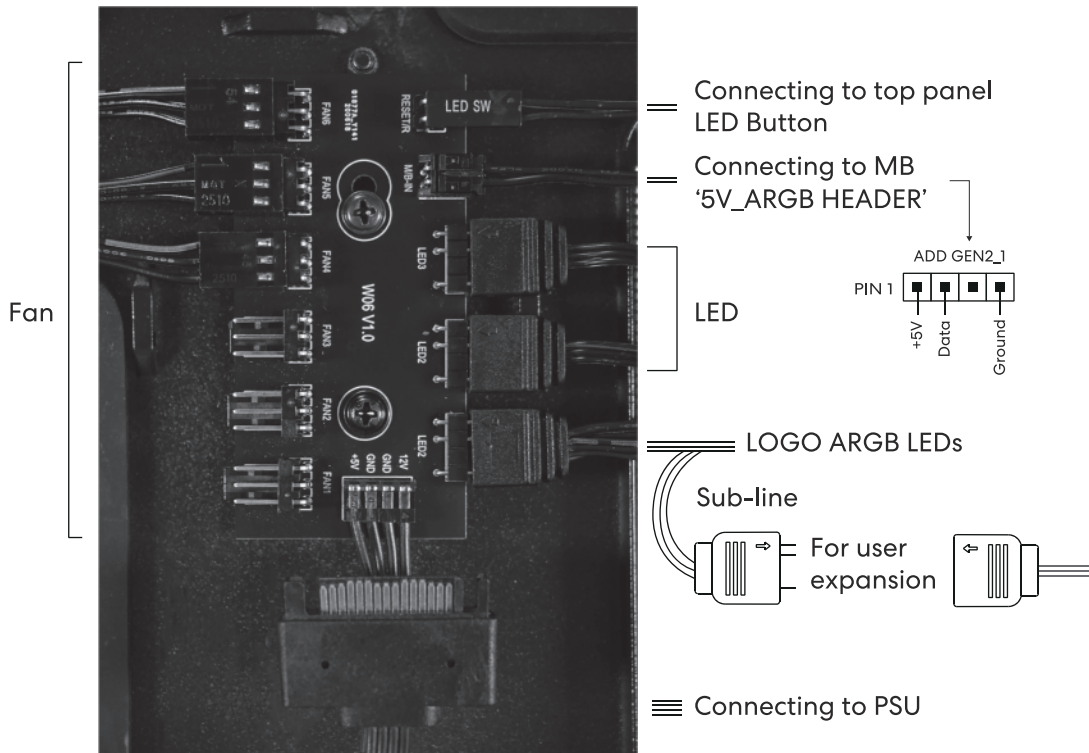

Cable installation guide / Guide d'installation des câbles / Installationsanleitung für Kabel / Guía de instalación de cables / 電源システムインジケータの配線の定義 / 電源-系統指示燈接線定義

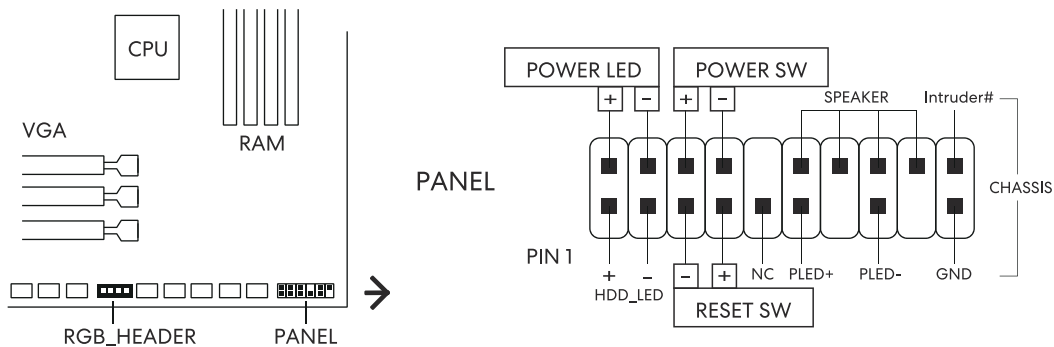



I/O port function / Fonction de port d'E/S / E/A-Port-Funktion  
 Función de puerto de E/S / I/Oポート機能の説明 / I/O port 功能説明

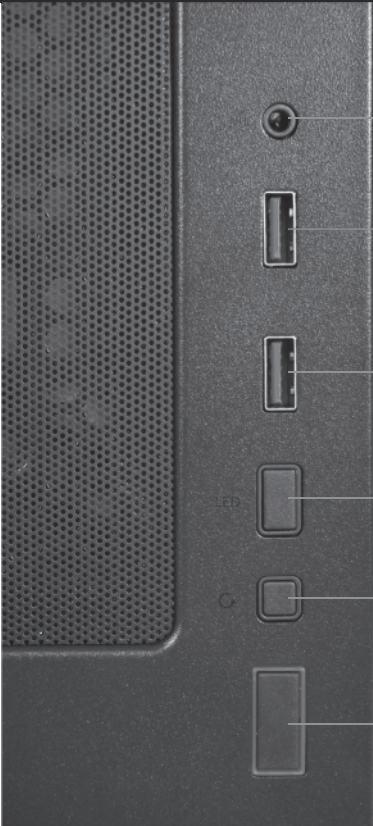

**HD Audio** 1x AUDIO / Microphone Combo Jack

Blue	10		9	Green
Black purple	8		7	Key
Yellow	6		5	Orange
Gray	4		3	N.C.
Red	2		1	GND+H.S. TUBE

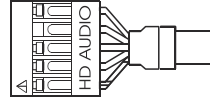

**USB 3.0** Supports motherboard  
 USB 3.0 20 Pin header

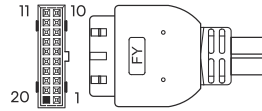

**LED Mode** 5 Lighting Effects, 7 Colors  
 Press 3 Sec to link with the motherboard

**Reset Button**

**Power Button**



Cable management / Gestion des câbles / Kabelmanagement  
 Mantenimiento de cable / ケーブル管理 / 整線

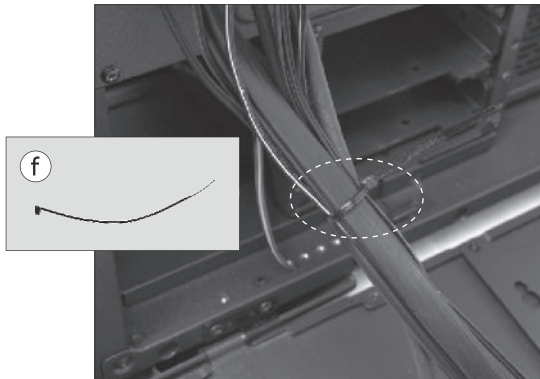



Top panel

120mm x2 or 140mm x2

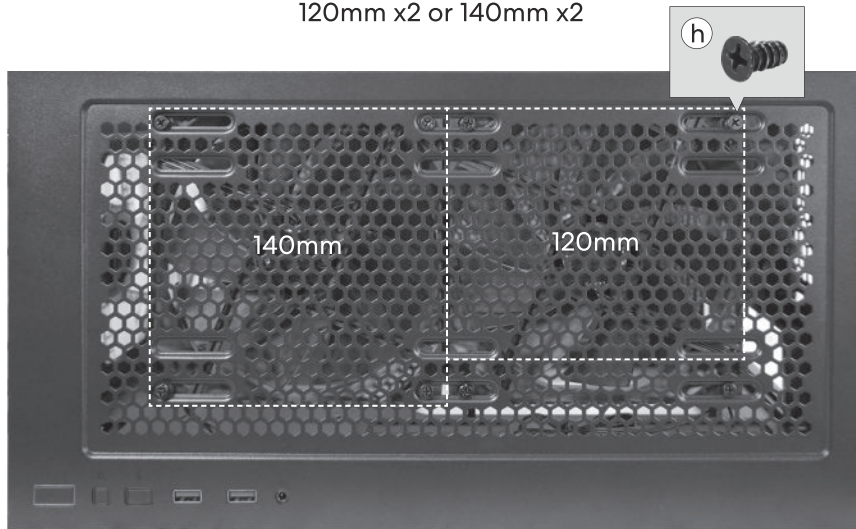

Inside

120mm x2

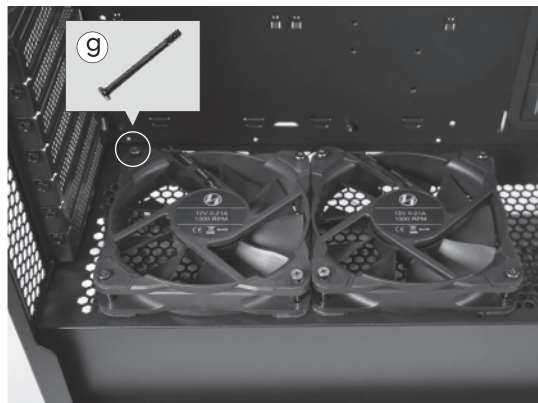
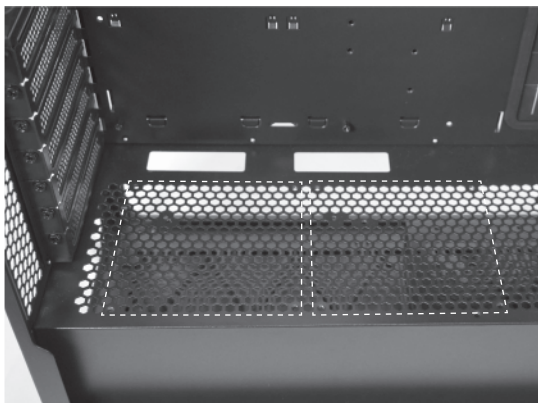

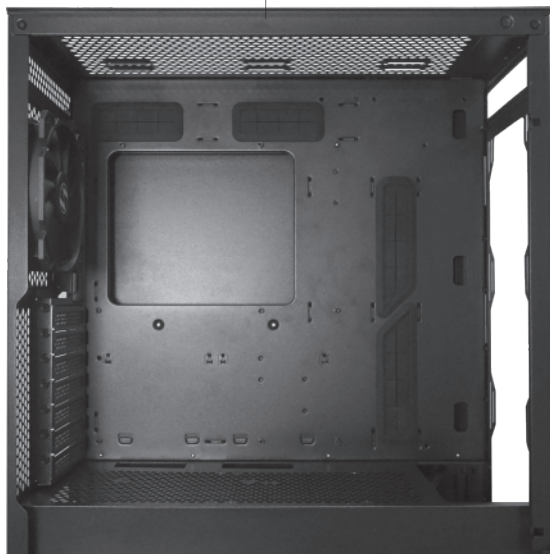

### Top panel

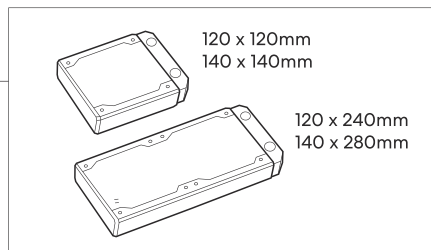

### Front panel

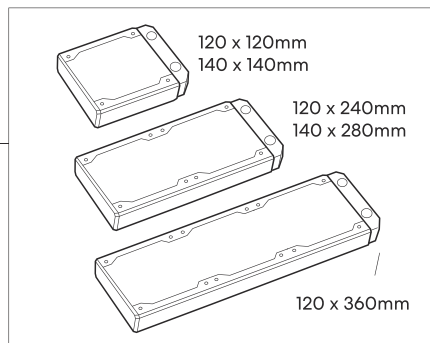



Top panel

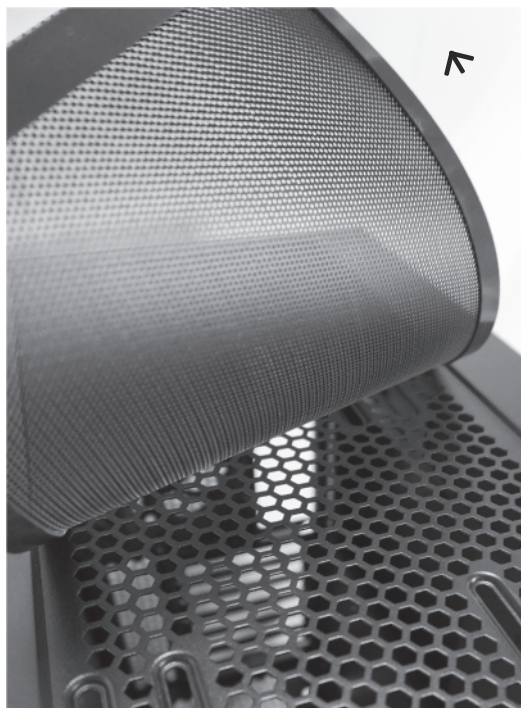

Bottom panel



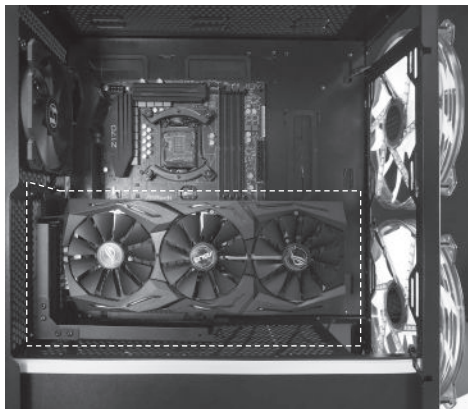
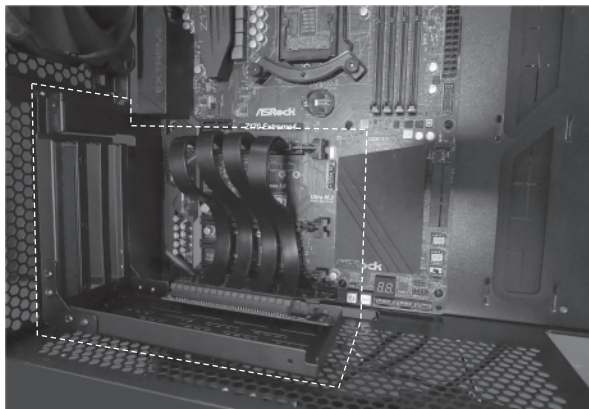

LANCOOL II - 1X  
Vertical GPU kit

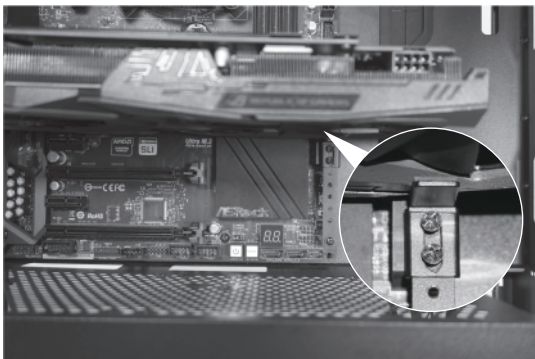

GB-001X  
Graphic card anti-sag bracket



LANCOOL II 2X  
Side Diffused LED strip

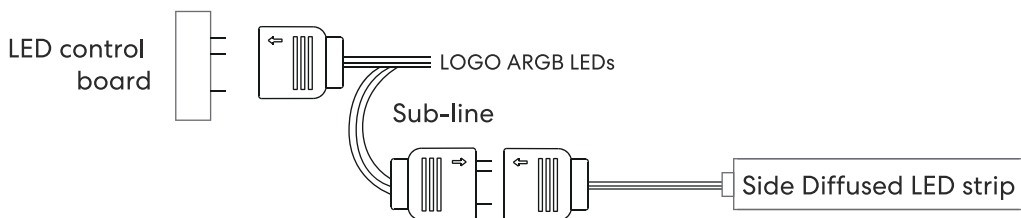

CPU air cooler

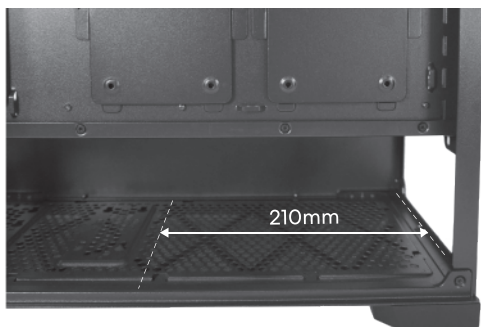
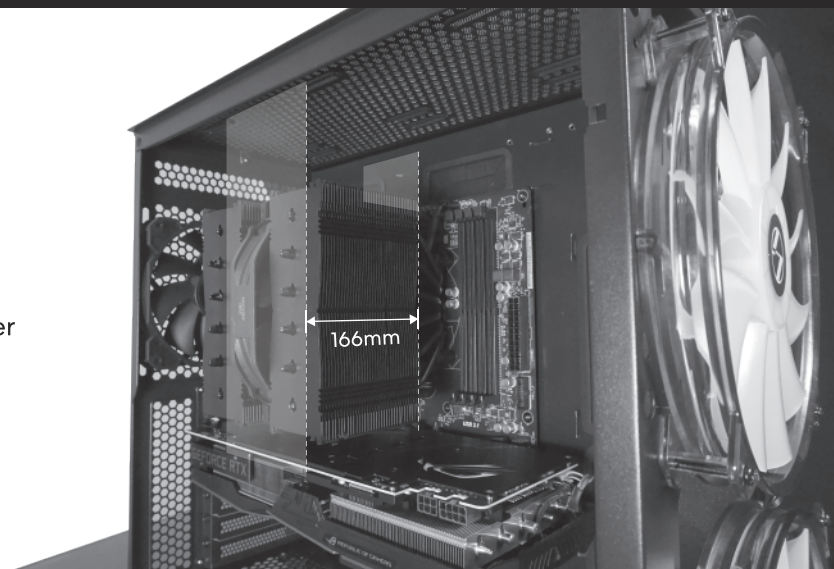

PSU Length

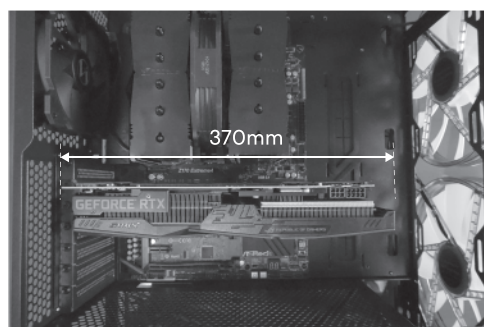

VGA Length

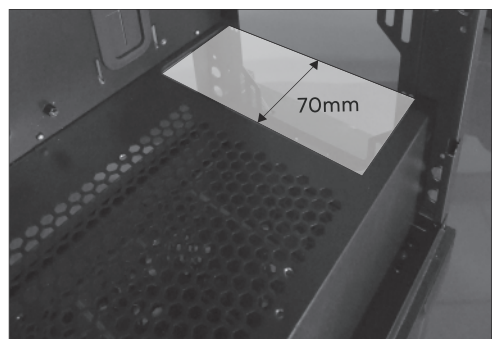

Radiator clearance

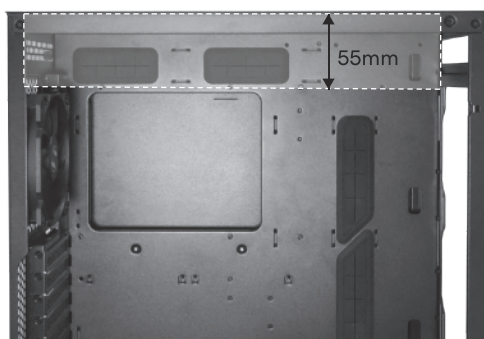

Top panel radiator clearance

## Specification

Model	LANCOOL 215
Dimensions	(D) 462mm x (W) 215mm x (H) 482mm
Motherboard	E-ATX(width: under 280mm)/ATX/M-ATX/ITX
PSU	210mm
Color	black
Materials	0.75mm SGCC (MB tray, and most of the interior) 4.0mm tempered glass / 0.7mm SGCC (exterior)
Fan Support	Front : 2 x 200mm or 2 x 140mm or 3x120 Top: 2 x 120mm or 2 x 140mm Rear: 1 x 120mm
Radiator	Front : 1 x 280/360mm Top: 1 x 240 / 280mm
VGA Length	370mm
CPU Clearance	166mm
Drive	Behind MB Tray: 2 x 2.5 SSD Hard Drive Cage: 2 x 3.5 HDD or 1x 2.5SSD
Slot	7
I/O Ports	LED button for lighting mode control 1 x TRRS AUDIO 2 x USB 3.0
Dust Filters	1 x Top (magnetic), 1 x Bottom (tray)
Incl Fans	front top : 2 x included 200mm 3-PIN 800 RPM ARGB fans rear top : 1 X 120mm 1100 RPM Fans