

DH-IPC-HFW1230T-ZS-S4

2MP Entry IR Vari-focal Bullet Network Camera



Series Overview

With features of simple installation, easy operation, and high performance-cost ratio, Dahua Entry series network camera is applicable to small and medium-sized scenes, such as homes/residences, small-sized retail stores, and other small and medium-sized enterprises.

Functions

Smart H.265+ & Smart H.264+

With advanced scene-adaptive rate control algorithm, Dahua smart encoding technology realizes the higher encoding efficiency than H.265 and H.264, provides high-quality video, and reduces the cost of storage and transmission.

Motion Detection

When moving objects appear in the monitoring image, Dahua Motion Detection (General) technology triggers alarm or records.

Smart Illumination

Dahua Smart Illumination technology can display image in the environment of low illuminance or completely dark environment. According to the distance of the targets, the camera adjusts illuminations intensity automatically to display the details of the moving target.

- 2MP 1/2.8" CMOS image sensor, low luminance, and high definition image.
- Outputs max. 2MP (1920 × 1080)@25/30 fps.
- H.265 codec, high compression rate, ultra-low bit rate.
- Built-in IR LED, and the max. illumination distance is 50 m.
- ROI, SMART H.264 +/H.265+, flexible coding, applicable to various bandwidth and storage environments.
- Rotation mode, WDR, 3D NR, HLC, BLC, digital watermarking, applicable to various monitoring scenes.
- Abnormality detection: Motion detection, privacy masking, no SD card, SD card full, SD card error, network disconnection, IP conflict, and illegal access.
- Supports max. 256 GB SD card.
- 12V DC/PoE power supply.
- IP67 protection.



Cyber Security

Dahua network camera is equipped with a series of key security technologies, such as security authentication and authorization, access control, trusted protection, encrypted transmission, and encrypted storage, which improve its security defense and data protection, and prevent malicious programs from invading the device.

Protection (IP67, wide voltage)

IP67: The camera passes a series of strict test on dust and soak. It has dust-proof function, and the enclosure can work normal after soaking in 1 m deep water for 30 minutes.

Wide voltage: The camera allows $\pm 30\%$ input voltage tolerance (wide voltage range), and it is widely applied to outdoor environment with instable voltage.

Technical Specification

Camera

Image Sensor	1/2.8" CMOS
Max. Resolution	1920 (H) × 1080 (V)
ROM	16 MB
RAM	128 MB
Scanning System	Progressive
Electronic Shutter Speed	Auto/Manual 1/3 s–1/100,000 s
Min. Illumination	0.008 Lux@F1.7 (Color, 30 IRE) 0.0008 Lux@F1.7 (B/W, 30 IRE) 0 Lux (Illuminator on)
S/N Ratio	> 56 dB
Illumination Distance	50 m (164.04 ft) (IR)
Illuminator On/Off Control	Auto; Manual
Illuminator Number	2 (IR)
Pan/Tilt/Rotation Range	Pan: 0°–360° Tilt: 0°–90° Rotation: 0°–360°

Lens

Lens Type	Motorized vari-focal				
Lens Mount	φ14				
Focal Length	2.8 mm–12 mm				
Max. Aperture	F1.7				
Field of View	Horizontal: 101°–33.5°; Vertical: 52.5°–19°; Diagonal: 125°–38.5°				
Iris Control	Fixed				
Close Focus Distance	0.8 m (2.6 lb)				
DORI Distance	Lens	Detect	Observe	Recognize	Identify
	W	48 m (157.48 ft)	19 m (62.34 ft)	10 m (32.81 ft)	5m (16.40 ft)
	T	131 m (429.79 ft)	52 m (170.60 ft)	26 m (85.30 ft)	13m (42.65 ft)

Video

Video Compression	H.265; H.264; H.264B; MJPEG (Only supported by the sub stream)
Smart Codec	Smart H.265+; Smart H.264+
Video Frame Rate	Main stream:1920 × 1080@1–25/30 fps Sub stream: 704 × 576@1–25 fps/704 × 480@1–30 fps *The values above are the max. frame rates of each stream; for multiple streams, the values will be subjected to the total encoding capacity.
Stream Capability	2 streams
Resolution	1080p (1920 × 1080); 1.3M (1280 × 960); 720p (1280 × 720); D1 (704 × 576/704 × 480); VGA (640 × 480); CIF (352 × 288/352 × 240)
Bit Rate Control	CBR/VBR
Video Bit Rate	H.264: 32 kbps–6144 kbps H.265: 12 kbps–6144 kbps
Day/Night	Auto(ICR)/Color/B/W

BLC	Yes
HLC	Yes
WDR	DWDR
White Balance	Auto; natural; street lamp; outdoor; manual; regional custom
Gain Control	Auto; manual
Noise Reduction	3D NR
Motion Detection	OFF/ON (4 areas, rectangular)
Region of Interest (RoI)	Yes (4 areas)
Smart Illumination	Yes
Image Rotation	0°/90°/180°/270° (Support 90°/270° with 1080p resolution and lower)
Mirror	Yes
Privacy Masking	4 areas

Alarm

Alarm Event	No SD card; SD card full; SD card error; network disconnection; IP conflict; illegal access; motion detection; video tampering; security exception; defocus detection
-------------	---

Network

Network Port	RJ-45 (10/100 Base-T)
SDK and API	Yes
Cyber Security	Video encryption; configuration encryption; Digest; WSSE; account lockout; security logs; generation and importing of X.509 certification; HTTPS; trusted boot; trusted execution; trusted upgrade
Network Protocol	IPv4; IPv6; HTTP; TCP; UDP; ARP; RTP; RTSP; SMTP; FTP; DHCP; DNS; NTP; Multicast; DDNS
Interoperability	ONVIF (Profile S/Profile T); CGI; P2P; Milestone
User/Host	6
Storage	FTP; Micro SD card (Support max. 256 G)
Browser	IE Chrome Firefox
Management Software	Smart PSS; DSS; DMSS
Mobile Client	IOS; Android

Certification

Certifications	CE-LVD: EN62368-1 CE-EMC: Electromagnetic Compatibility Directive 2014/30/EU FCC: 47 CFR FCC Part 15, Subpart B
----------------	---

Power

Power Supply	12V DC/PoE (802.3af)
Power Consumption	Basic: 1.8W (12 V DC); 2.3W (PoE) Max. (H.265 + ICR + IR intensity): 4.3 W (12V DC); 5.5 W (PoE)

Environment

Operating Temperature	-30 °C to +60 °C (-22 °F to 140 °F)
Operating Humidity	≤95%
Storage Temperature	NA
Protection	IP67
Storage Conditions	-40°C to +60°C (-40°F to +140°F)

Structure

Casing	Metal
Product Dimensions	244.1 mm × Ø90.4 mm (9.61" × Ø3.56")
Net Weight	0.86 kg (1.90 lb)
Gross Weight	1.12 kg (2.47 lb)

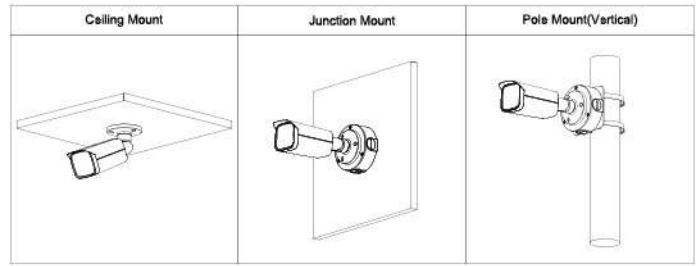

Dimensions (mm[inch])

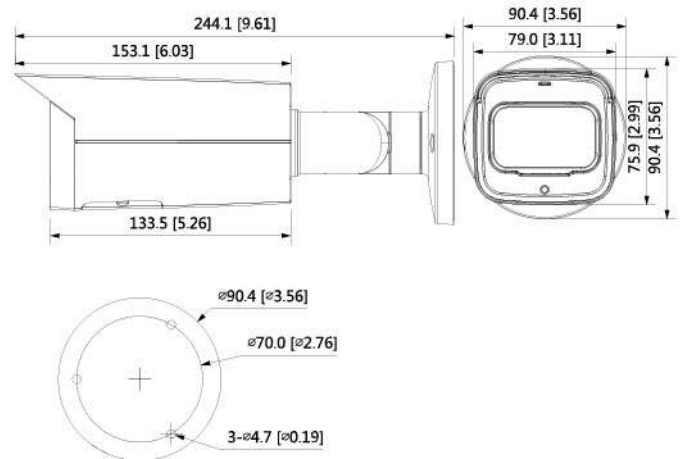

Ordering Information

Type	Model	Description
2MP Camera	DH-IPC-HFW1230T-ZS-S4	2MP Entry IR Vari-focal Dome Network Camera
Accessories (Optional)	PFA130-E	Junction Mount Bracket
	PFA130-E+PFA152-E	Pole Mount Bracket
	PFM321D	12V DC 1A Power Adapter
	LR1002-1ET/1EC	Single-port Long Reach Ethernet over Coax Extender
	PFM900-E	Integrated Mount Tester
	PFM114	TLC SD Card

Accessories

Optional:



PFA130-E
Junction Mount Bracket



PFA130-E+PFA152-E
Pole Mount Bracket



PFM321D
DC12V1A Power Adapter



LR1002-1ET/1EC
Single-port Long Reach Ethernet over Coax Extender



PFM900-E
Integrated Mount Tester



PFM114
TLC SD Card