

DS-2CE16D8T-(A)IT3ZF 2 MP Ultra-Low Light Bullet Camera



Key Features

- 2 MP high performance CMOS
- Ultra-low light
- 1920 × 1080 resolution
- 2.7 mm to 13.5 mm varifocal lens, auto focus
- 130 dB true WDR, 3D DNR
- Smart IR, up to 80 m IR distance
- 4 in 1 video output (switchable TVI/AHD/CVI/CVBS)
- IP67
- Up the coax (HIKVISION-C)



Specification

| Camera | |
|--------------------------|--|
| Image Sensor | 2 MP CMOS |
| Signal System | PAL/NTSC |
| Resolution | 1920 (H) × 1080 (V) |
| Frame Rate | PAL: 1080p@25fps NTSC: 1080p@30fps |
| Min. Illumination | Color: 0.003 Lux @ (F1.2, AGC ON), 0 Lux with IR |
| Shutter Time | PAL: 1/25 s to 1/50, 000 s NTSC: 1/30 s to 1/50, 000 s |
| Slow Shutter | MAX. 16 times |
| Lens | 2.7 mm to 13.5 mm motorized, auto focus |
| Horizontal Field of View | 103° to 32.1° |
| Lens Mount | Φ14 |
| Day & Night | ICR |
| WDR (Wide Dynamic Range) | ≥ 130 dB |
| Angle Adjustment | Pan: 0° to 360°, Tilt: 0° to 90°, Rotate: 0° to 360° |
| Menu | |
| Image Mode | STD/HIGH-SAT |
| AGC | Yes |
| Day/Night Mode | Auto/Color/BW (Black and White) |
| White Balance | Auto/Manual |
| AE (Auto Exposure) Mode | WDR/BLC/HLC/Global |
| Privacy Mask | 4 programmable privacy masks |
| Motion Detection | 4 programmable motion areas |
| NR (Noise Reduction) | 3D DNR/2D DNR |
| Language | English |
| Functions | Brightness, Sharpness, Mirror, Smart IR |
| Interface | |
| Video Output | Switchable TVI/AHD/CVI/CVBS |
| General | |
| Operating Conditions | -40 °C to 60 °C (-40 °F to 140 °F), humidity: 90% or less (non-condensing) |
| Power Supply | 12 VDC ±25%, 24 VAC ±25% <i>*You are recommended to use one power adapter to supply the power for one camera.</i> |
| Power Consumption | Max. 7.5W, -A: Max. 9W |
| Ingress Protection | IP67 |
| Material | Metal |
| IR Range | Up to 80 m |
| Communication | HIKVISION-C |
| Dimensions | 85 mm × 92 mm × 269.6 mm (3.3" × 3.6" × 10.6") |
| Weight | Approx. 910 g (2.01 lb.), -A: Approx. 940 g (2.07 lb.) |

Order Models

DS-2CE16D8T-AIT3ZF
 DS-2CE16D8T-IT3ZF

Dimension

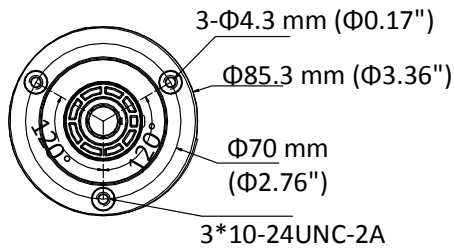
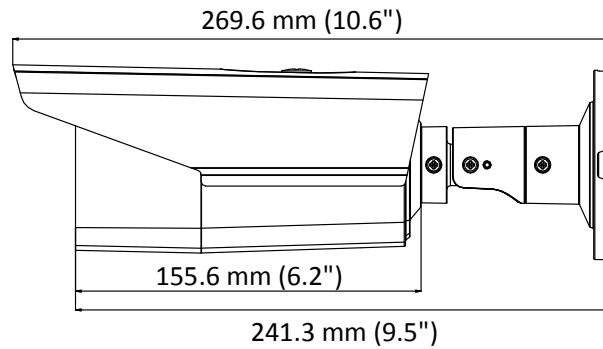
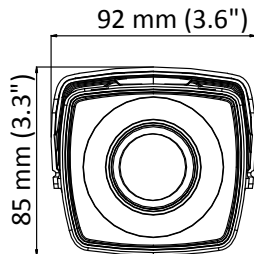

Distributed by

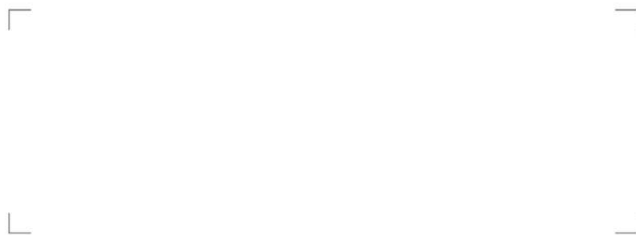

HIKVISION

Headquarters

No.555 Qianmo Road, Binjiang District,
 Hangzhou 310051, China
 T +86-571-8807-5998
 overseasbusiness@hikvision.com

Hikvision USA
 T +1-909-895-0400
 sales.usa@hikvision.com

Hikvision Europe
 T +31-23-55-42-770
 info.eu@hikvision.com

Hikvision Middle East
 T +971-4-8816086
 salesme@hikvision.com

Hikvision Russia
 T +7-495-669-67-99
 saleru@hikvision.com

Hikvision India
 T +91-22-28469900
 sales@pramahikvision.com

Hikvision Italy
 T +39-0438-6902
 info.it@hikvision.com

Hikvision France
 T +33(0)1-85-330-450
 info.fr@hikvision.com

Hikvision Spain
 T +34-91-737-16-55
 info.es@hikvision.com

Hikvision Poland
 T +48-22-460-01-50
 poland@hikvision.com

Hikvision UK
 T +01628-902140
 support.uk@hikvision.com

Hikvision Singapore
 T +65-6684-4718
 sg@hikvision.com

Hikvision Oceania
 T +61-2-8599-4233
 salesau@hikvision.com

Hikvision Canada
 T +1-909-895-0400
 sales.usa@hikvision.com

Hikvision Korea
 T +82-31-731-8841
 sales.korea@hikvision.com

Hikvision Brazil
 T +55 11 3318-0050
 Latam.support@hikvision.com

Hikvision Africa
 T +27 (0) 0351172
 sale.africa@hikvision.com

Hikvision Hong Kong
 T +852-2151-1761

Accessory

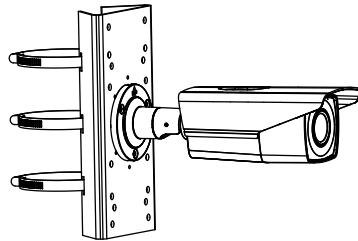

DS-1275ZJ-SUS
Vertical pole mount

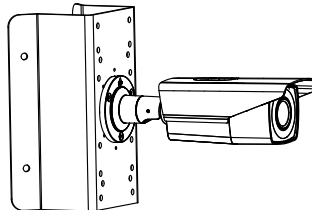

DS-1276ZJ-SUS
Corner mount

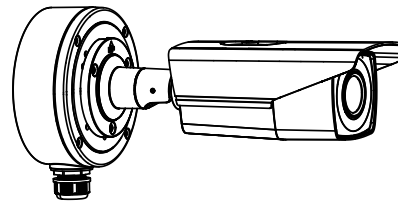

DS-1280ZJ-S
Junction box

Distributed by



HIKVISION

Headquarters

No.555 Qianmo Road, Binjiang District,
Hangzhou 310051, China
T +86-571-8807-5998
overseasbusiness@hikvision.com

Hikvision USA
T +1-909-895-0400
sales.usa@hikvision.com

Hikvision Europe
T +31-23-55-42-770
info.eu@hikvision.com

Hikvision Middle East
T +971-4-8816086
salesme@hikvision.com

Hikvision Russia
T +7-495-669-67-99
saleru@hikvision.com

Hikvision India
T +91-22-28469900
sales@pramahikvision.com

Hikvision Italy
T +39-0438-6902
info.it@hikvision.com

Hikvision France
T +33(0)1-85-330-450
info.fr@hikvision.com

Hikvision Spain
T +34-91-737-16-55
info.es@hikvision.com

Hikvision Poland
T +48-22-460-01-50
poland@hikvision.com

Hikvision UK
T +01628-902140
support.uk@hikvision.com

Hikvision Singapore
T +65-6684-4718
sg@hikvision.com

Hikvision Oceania
T +61-2-8599-4233
salesau@hikvision.com

Hikvision Canada
T +1-909-895-0400
sales.usa@hikvision.com

Hikvision Korea
T +82-31-731-8841
sales.korea@hikvision.com

Hikvision Brazil
T +55 11 3318-0050
Latam.support@hikvision.com

Hikvision Africa
T +27 (0) 0351172
sale.africa@hikvision.com

Hikvision Hong Kong
T +852-2151-1761